

# **HARDWARE**

**flight case and cabinet components**

**EXTRUSIONS - vers. 02/2014**

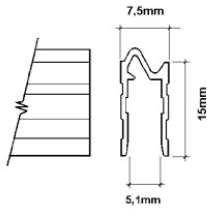

### AL1301

Hybrid location (fit for panel thickness 5 mm), h = 15 mm

material: Aluminium 12/10 (4 mt)  
 finish: Self colour  
 weight: 120 gr/mt

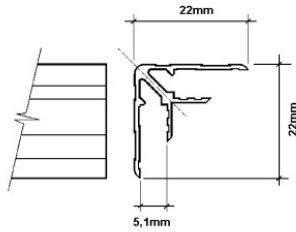

### AL2301

Double angle (fit for panel thickness 5 mm) 22x22 mm. Short inner corner

material: Aluminium 12/10 (4 mt)  
 finish: Self colour  
 weight: 210 gr/mt

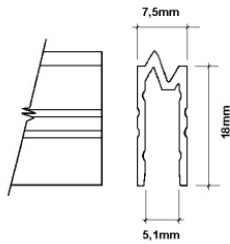

### AL1311

Hybrid location (fit for panel thickness 5 mm), h = 18 mm

material: Aluminium 12/10 (4 mt)  
 finish: Self colour  
 weight: 145 gr/mt

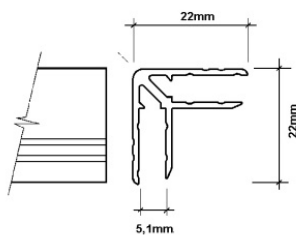

### AL2311

Double angle (fit for panel thickness 5 mm) 22x22 mm. Long inner corner

material: Aluminium 12/10 (4 mt)  
 finish: Self colour  
 weight: 250 gr/mt

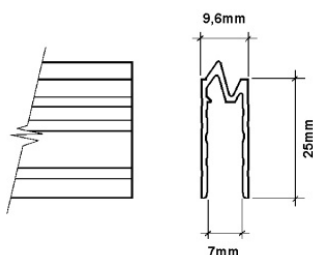

### AL1341

Hybrid location (fit for panel thickness 7 mm), h = 25 mm

material: Aluminium 13/10 (4 mt)  
 finish: Self colour  
 weight: 220 gr/mt

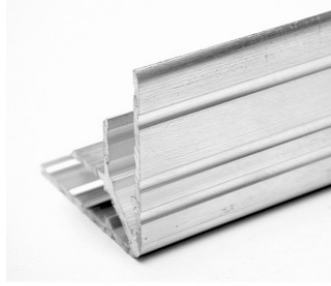
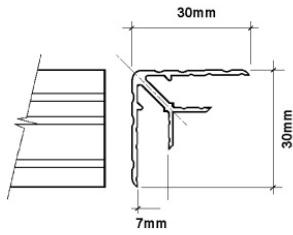

### AL2341

Double angle (fit for panel thickness 7 mm) 30x30 mm.

material: Aluminium 13/10 (4 mt)  
 finish: Self colour  
 weight: 310 gr/mt

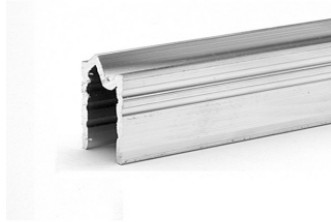
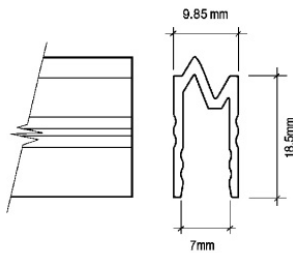

### AL1351

Hybrid location (fit for panel thickness 7 mm), h = 18,5 mm

material: Aluminium 14/10 (4 mt)  
 finish: Self colour  
 weight: 190 gr/mt

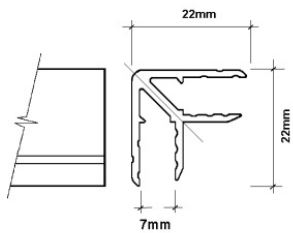

### AL2351

Double angle (fit for panel thickness 7 mm) 22x22mm

material: Aluminium 14/10 (4 mt)  
 finish: Self colour  
 weight: 290 gr/mt

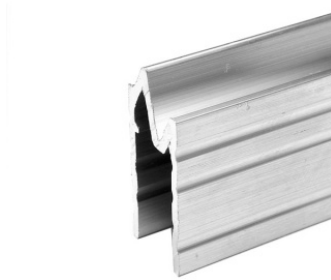
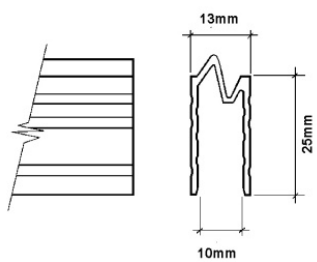

### AL1371

Hybrid location (fit for panel thickness 10 mm), h = 25 mm

material: Aluminium 15/10 (4 mt)  
 finish: Self colour  
 weight: 280 gr/mt

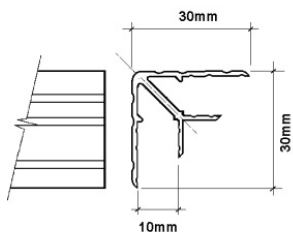

### AL2371

Double angle (fit for panel thickness 10 mm) 30x30 mm

material: Aluminium 15/10 (4 mt)  
 finish: Self colour  
 weight: 370 gr/mt

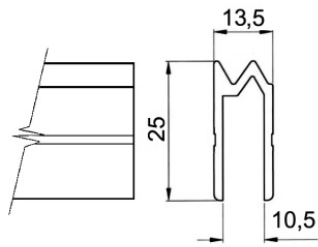

### AL1381

Hybrid location (fit for panel thickness 10,5 mm), h = 25 mm

material: Aluminium 15/10 (4 mt)  
 finish: Self colour  
 weight: 280 gr/mt

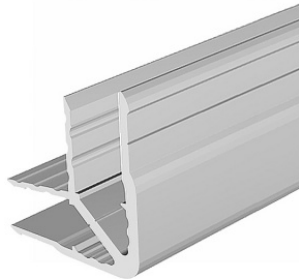
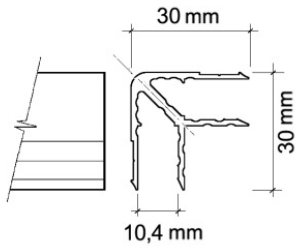

### AL2381

Double angle (fit for panel thickness 10,5 mm) 30x30 mm

material: Aluminium 15/10 (4 mt)  
 finish: Self colour  
 weight: 380 gr/mt

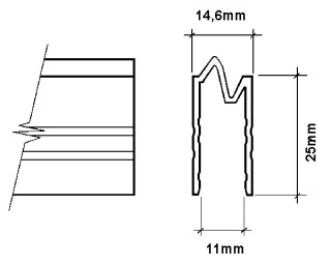

### AL1391

Hybrid location (fit for panel thickness 11 mm), h = 25 mm

material: Aluminium 18/10 (4 mt)  
 finish: Self colour  
 weight: 310 gr/mt

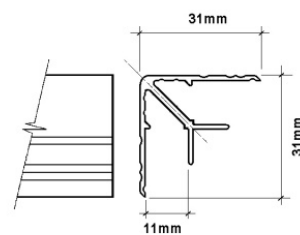

### AL2391

Double angle (fit for panel thickness 11 mm) 31x31 mm

material: Aluminium 18/10 (4 mt)  
 finish: Self colour  
 weight: 430 gr/mt

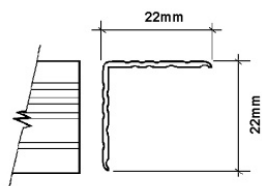

### AL3341

Single angle 22x22 mm

material: Aluminium 13/10 (4 mt)  
 finish: Self colour  
 weight: 120 gr/mt

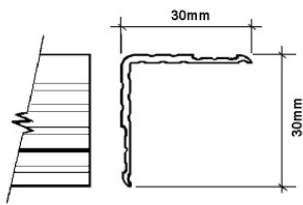

### AL3301

Single angle 30x30 mm

material: Aluminium 20/10 (4 mt)  
 finish: Self colour  
 weight: 240 gr/mt

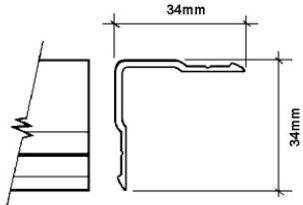

### AL3321

Single angle 34x34 mm

material: Aluminium 20/10 (4 mt)  
 finish: Self colour  
 weight: 300 gr/mt

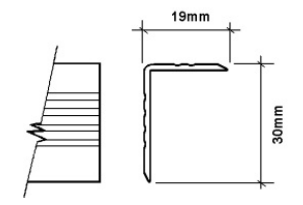

### AL3332

Single unequal angle 30x19.5 mm

material: Aluminium 15/10 (4 mt)  
 finish: Self colour  
 weight: 160 gr/mt

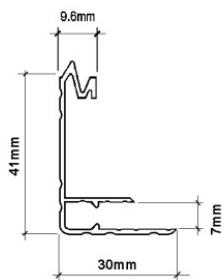

### AL4371

Lid maker (fit for panel thickness 7 mm) 30x41 mm

material: Aluminium 15/10 (4 mt)  
 finish: Self colour  
 weight: 411 gr/mt



### AL4381

Lid maker (fit for panel thickness 7 mm) 30x65 mm

material: Aluminium 15/10 (4 mt)  
 finish: Self colour  
 weight: 497 gr/mt

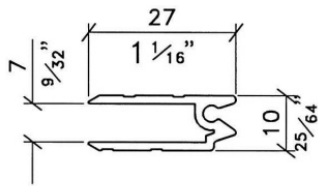

### ALP2305

Hybrid location with gasket groove (dust protection) fit for panel thickness 7 mm, h = 27 mm

material: Aluminium  
weight: 1,04 kg. (4 m.)

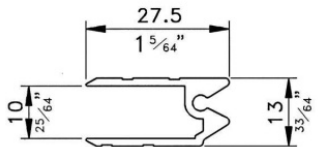

### ALP2315

Hybrid location with gasket groove (dust protection) fit for panel thickness 10 mm, h = 27,5 mm

material: Aluminium  
weight: 1,24 kg. (4 m.)



### ALP03G

Dust proof gasket for ALP2305 e ALP2315

material: Plastic  
weight: 100 gr.

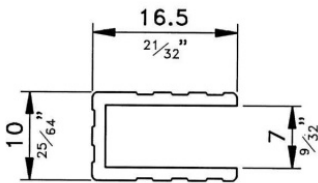

### ALP2210

Trim U-Shape (fit for panel thickness 7 mm), h = 16,5 mm

material: Aluminium 20/10 (4 mt)  
finish: Self colour  
weight: 150 gr/mt

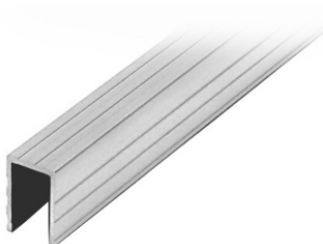
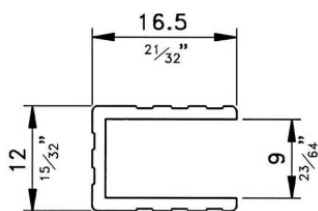

### ALP2215

Trim U-Shape (fit for panel thickness 9 mm), h = 16,5 mm

material: Aluminium 20/10 (4 mt)  
finish: Self colour  
weight: 160 gr/mt

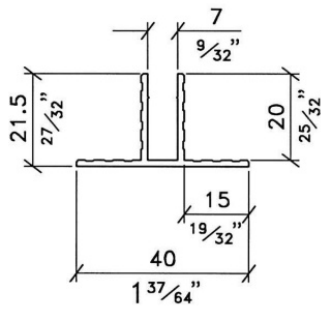

### ALP2220

Divider extrusion hat-shape (fit for panel thickness 7 mm), L=40mm

material: Aluminium 20/10 (4 mt)

finish: Self colour

weight: 310 gr/mt

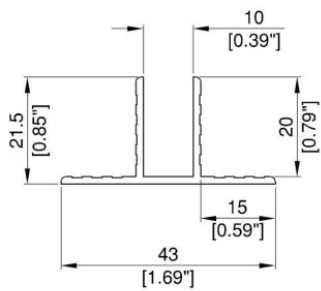

### ALP2226

Divider extrusion hat-shape (fit for panel thickness 10 mm), L=42mm

material: Aluminium 20/10 (4 mt)

finish: Self colour

weight: 320 gr/mt

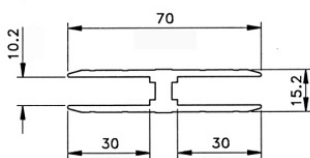

### ALP2340

Panel extension H-shape (fit for panel thickness 10 mm), h=70mm

material: Aluminium 25/10 (4 mt)

finish: Self colour

weight: 1070 gr/mt

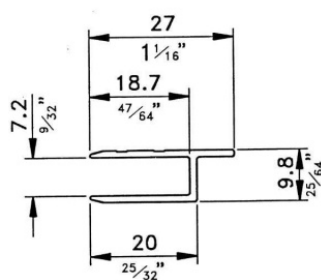

### ALP2355

Door Trim (fit for panel thickness 7 mm), h=27 mm

material: Aluminium 20/10 (4 mt)

finish: Self colour

weight: 180 gr/mt

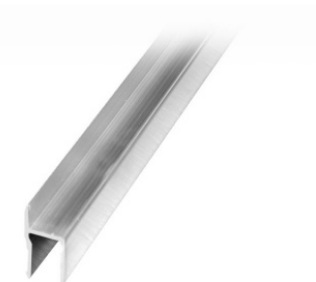
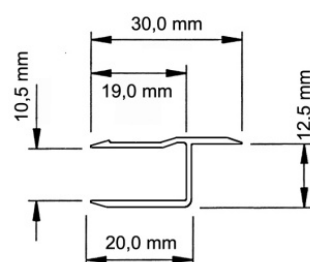

### ALP2358

Door Trim (fit for panel thickness 10,5 mm), h=30 mm

material: Aluminium 20/10 (4 mt)

finish: Self colour

weight: 185 gr/mt

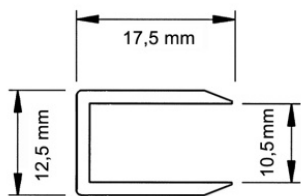

## ALP2216

Trim U-Shape (fit for panel thickness 10,5 mm), h = 17,5 mm

material: Aluminium 20/10 (4 mt)

finish: Self colour

weight: 130 gr/mt